



ASSEMBLY INSTRUCTIONS



CROWN MARK (CRWN)

MODEL: B9100-1 SAWYER DRESSER

Thank you for purchasing this quality product. Be sure to check all packing material carefully for small parts which may have come loose inside the carton during shipment. Identify and count all parts and compare with hardware list as below:

STEP 1

(BOX 1) BOX OF DRESSER			
ITEM	DRAWING	DESCRIPTION	QTY
A		DRESSER	1
B		BOTTOM LEG	4
C		SUPPORT LEG	1

(BOX 1) BOX OF DRESSER (HARDWARE LIST)				
ITEM	DRAWING	DESCRIPTION	DIMENSION	QTY
D		JCBB (M8) WITH WASHER	8 x P1.0 x 50MM	4
E		ALLEN KEY M5	5 x 35 x 55MM	1

Step 1 : Attach and tighten the DRESSER bottom leg (B) to the bottom frame and insert JCBB (D) With Washer (E) as shown.

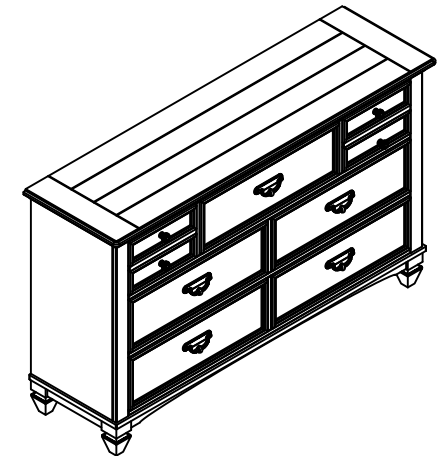
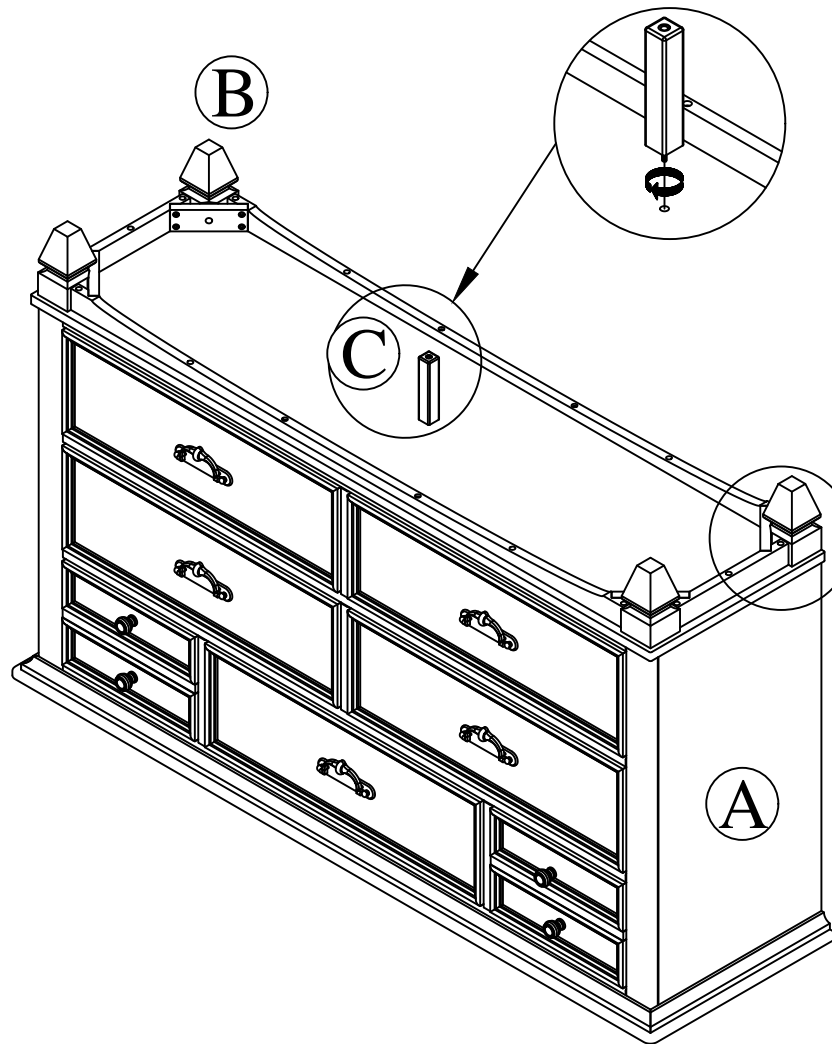

COMPLETED ASSEMBLY

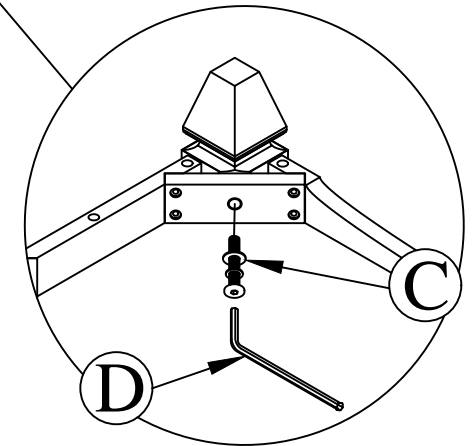

NOTE: MUST TIGHTEN SCREW PERIODICALLY. WITH USE SCREWS WILL BECOME LOOSE CHECK THIGHT OF ALL SREWS EVERY 6-8 WEEKS.
CLEANING INSTRUCTION
 After assembled, clean & polish the complete parts if necessary with soft cloth ang industrial recognized furniture polish.

THE ANTI TIPPING HARDWARE IS LOCATED IN THE RIGHT SIDE FRONT DRAWER OF DRESSER
 THE HARDWARE IS LOCATED IN THE PACKING ITEMS

MADE IN MALAYSIA