

# ASSEMBLY INSTRUCTIONS



## CROWN MARK (CRWN)



MODEL: B9100-1 SAWYER DRESSER & B9100-11 SAWYER DRESSER TOP

Thank you for purchasing this quality product. Be sure to check all packing material carefully for small parts which may have come loose inside the carton during shipment. Identify and count all parts and compare with hardware list as below:

### STEP 1

(BOX 1) BOX OF DRESSER			
ITEM	DRAWING	DESCRIPTION	QTY
A		DRESSER	1

(BOX 2) BOX OF MIRROR			
ITEM	DRAWING	DESCRIPTION	QTY
B		MIRROR	1
C		MIRROR SUPPORT (L & R)	2

(BOX 2) BOX OF MIRROR (HARDWARE LIST)				
ITEM	DRAWING	DESCRIPTION	DIMENSION	QTY
D		JCBC (M6) WITH WASHER	6 x P1.0 x 35MM	8
E		ALLEN KEY M4	4 x 35 x 65MM	1

Step 1 : Attach and tighten the Mirror Support (C) to the Dresser (A) and Mirror frame (B) at back, insert JCBC (M6) With Washer (D) as shown.

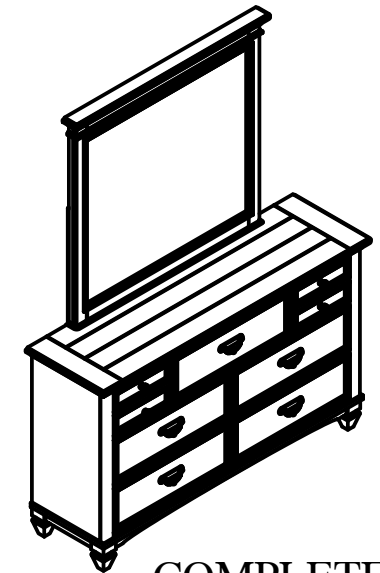
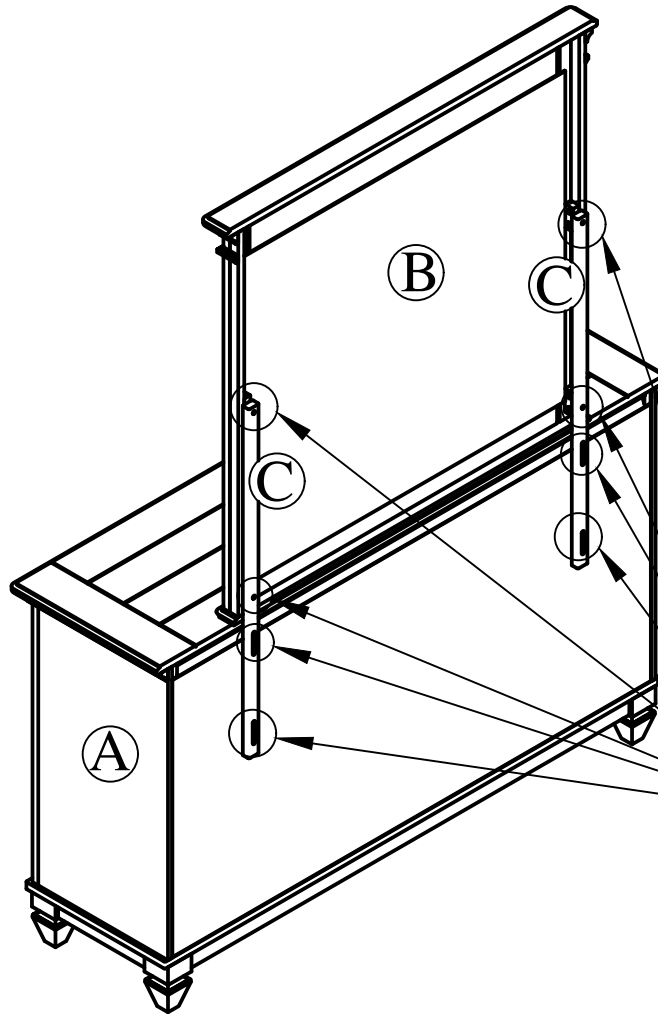

COMPLETED ASSEMBLY

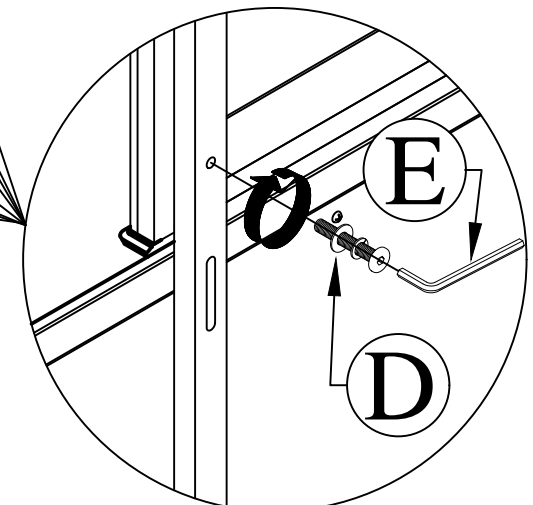

NOTE: MUST TIGHTEN SCREW PERIODICALLY. WITH USE SCREWS WILL BECOME LOOSE CHECK TIGHT OF ALL SREWS EVERY 6-8 WEEKS.

#### CLEANING INSTRUCTION

After assembled, clean & polish the complete parts if necessary with soft cloth and industrial recognized furniture polish.

THE HARDWARE IS LOCATED IN THE PACKING ITEMS

MADE IN MALAYSIA