

Thank you for purchasing this quality product. Be sure to check all packing material carefully for small parts that may have come loose inside the carton during shipment.

Hardware kit (552-319KDP46)			
No		Description	Q'Ty
A		Hexa Nut Ø8	4 pcs
B		Lock Washer Ø8	11 pcs
C		Flat Washer Ø8	11 pcs
D		Long Bolt Ø6 x 80mm	4 pcs
E		Short Bolt Ø6 x 40mm	3 pcs
F		Allen Key	1 pc
G		Key Wrench	1 pc

Key Parts			
No	Code	Description	Q'Ty
1	552-319KDP40	Chair Back	1 pc
2	552-319KDP41	Complete Seat	1 pc
3	552-319KDP42	Front Leg	2 pcs
4	552-319KDP01F	Floor glide	4 pcs

STEP 1

- Carefully lay Chair Back flat on a smooth flat surface to prevent scratches.
- Attach Complete Seat to Chair Back by inserting a Flat Washer (C), Lock Washer (B) with Short Bolt (E) into each of the hole on the back rail of the seat, and Long Bolt (D) into each of 2 holes in the Complete Seat corners. (See Detail A & B).
- Tighten screws with provided Allen Key (F) by turning clockwise until secure

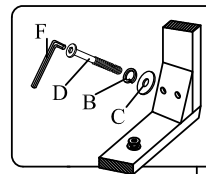

DETAIL B

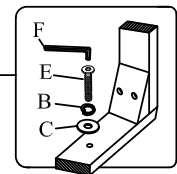
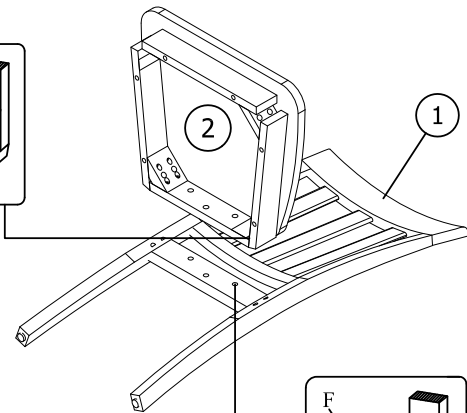

DETAIL A

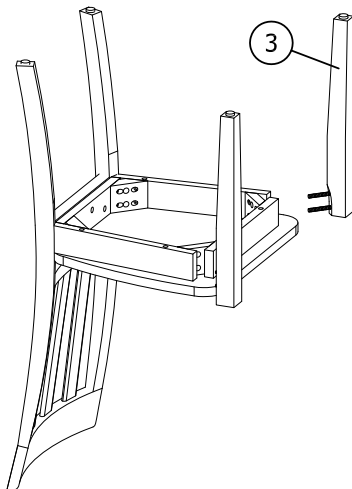

STEP 2

- Carefully turn Chair upside down and attach each Leg to the front corners of the Complete Seat.
- Place Flat Washer (C), Lock Washer (B) and Nut (A) on for each bolt, using provided Key Wrench (G).
- Do not fully tighten the Nuts at this stage until all the parts are in position (See Detail C).
- Be sure to tighten all screws and nuts prior to using Chair.

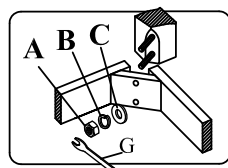

DETAIL C

