



ASSEMBLY INSTRUCTIONS

JOREN NIGHTSTAND

MODEL# DE-MASS-WN-B02-USB

LS SKU# 281440



CAUTION: PLEASE READ ALL INTRUCTIONS BEFORE STARTING THE ASSEMBLY OF THIS PRODUCT. THESE PIECES ARE HEAVY. IN ORDER PREVENT PERSONAL INJURY AND ENSURE THAT THIS PRODUCT IS NOT DAMAGED DURING THE ATTENTION: ASSEMBLY PROCESS, IT IS STRONGLY RECOMMENDED THAT YOU ENLIST THE ASSISTANCE OF ONE OR MORE PEOPLE.



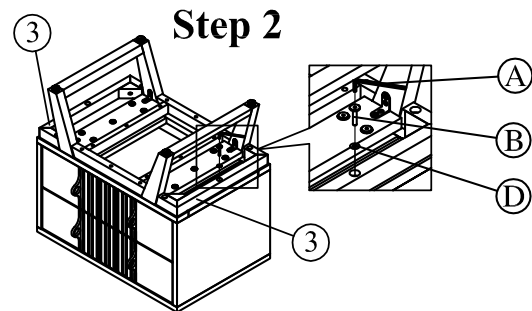
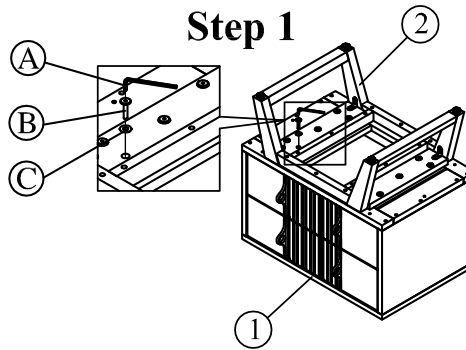
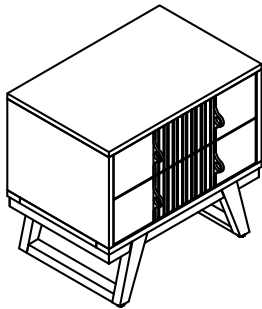

ATTENTION: VEUILLEZ LIRE TOUTES LES INSTRUCTIONS AVANT DE COMMENCER L'ASSEMBLAGE DE CE PRODUIT. LES PENDANT L'ASSEMBLAGE, POUR EUVITER BLESSURE ET POUR QUE LE PAS ENDOMMAGE CUIDADO OR DE LEER VOUS RECOMMANDONS DE FAIRE APPEL UN AUTRES PERSONNES.

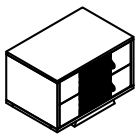
CUIDADO: FAVOR DE LEER TODAS LAS INSTRUCCIONES ANTES DE ENSAMBLAR SU PRODUCTO. ESTAS PIEZAS SON PESADAS. PARA PREVENIR HERIDAS PERSONALES Y ASEGURAR QUE SU PRODUCTO NO SEA DAÑADO MIENTRAS ES ENSAMBLADO. SE LE RECOMIENDA LA ASISTENCIA DE UNA O MAS PERSONAS.



ASSEMBLED DIMENSIONS:
60 cm x 40 cm x 55 cm

LIST OF PARTS AND HARDWARE			
No.	Description		Q'ty
1		Main body	1
2		Leg	2
3		Leg frame	2

LIST OF PARTS AND HARDWARE			
No.	Description		Q'ty
A		Allen Key 4mm	1
B		Bolt M6x30mm	16
C		Washer Ø8x18mm	10
D		Washer Ø6x12mm	6