

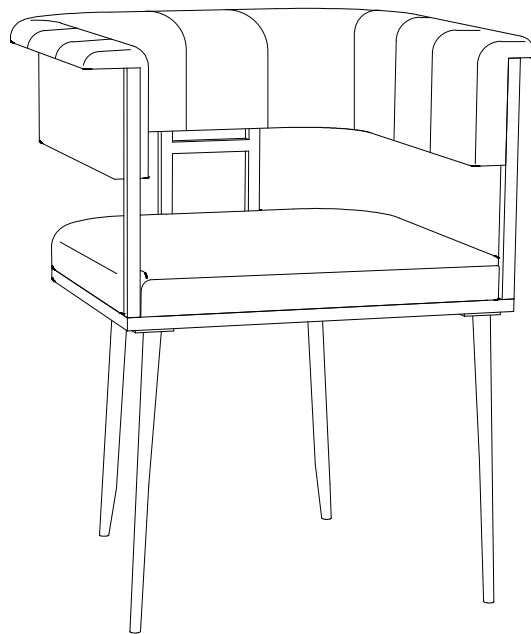

ASTRID VELVET CHAIR
TOV- D44022/D44023/D44024

ASTRID



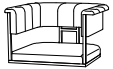

ASSEMBLY INSTRUCTIONS







PARTS LIST

LABEL	PICTURE	DESCRIPTION	QTY.
A		CHAIR	1
B		LEG -1	1
C		LEG -2	1

HARDWARE

LABEL	PICTURE	DESCRIPTION	QTY.
1		M6 x 20	1
2		M6 x 10	12
3		ALLEN KEY K4	1
4		Washers M6	13

BEFORE BEGINNING ASSEMBLY :

-  Read instructions cover to cover
-  Have two adults on hand for assembly
-  Do NOT assemble on flooring or carpet. Assemble on a clean non-marring surface (ex: packing foam)
-  Save all packaging until assembly is completed

ASSEMBLY STEPS

STEPS 1

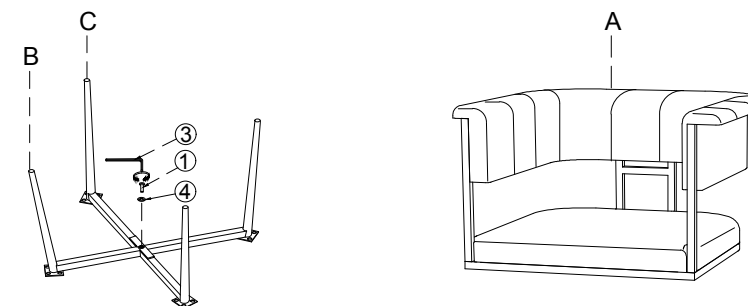

STEPS 2

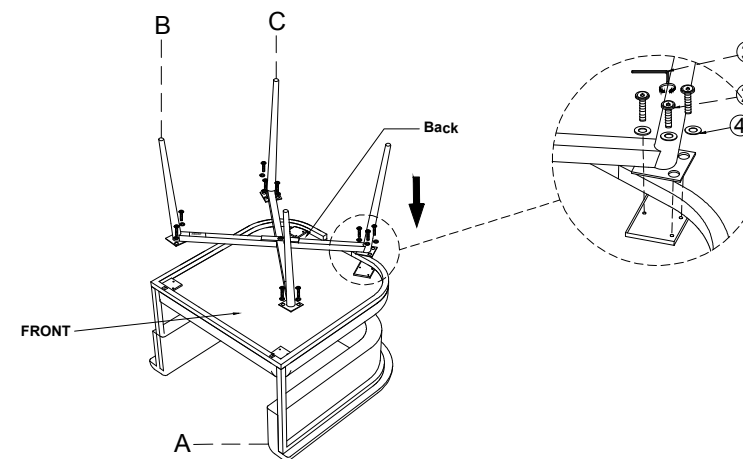

> Position the legs on the chair bottom as shown.

Keep the bolts loose during setup and tighten once all 4 legs are aligned properly.

CARE & MAINTENANCE



Do not put hot items directly on furniture surface.



Do not clean furniture with harsh cleansers or polish.



Dust and wipe up spills using a clean, non- colored, lint-free cloth.



Stains may be removed with mild soap solution and a damp cloth.



Do not place furniture under direct sunlight.



Do not place furniture near heating or cooling vents.



Do not write on furniture without a padded barrier to protect the surface.



Do not place furniture outside, for indoor use only.

CARE & MAINTENANCE FOR FABRIC



Advise dry-cleaning only.

In case of stains , use a clean towel with some warm water.

Chemicals are not advised.