

**ASTRID COUNTER STOOL**  
TOV- D44025/D44026

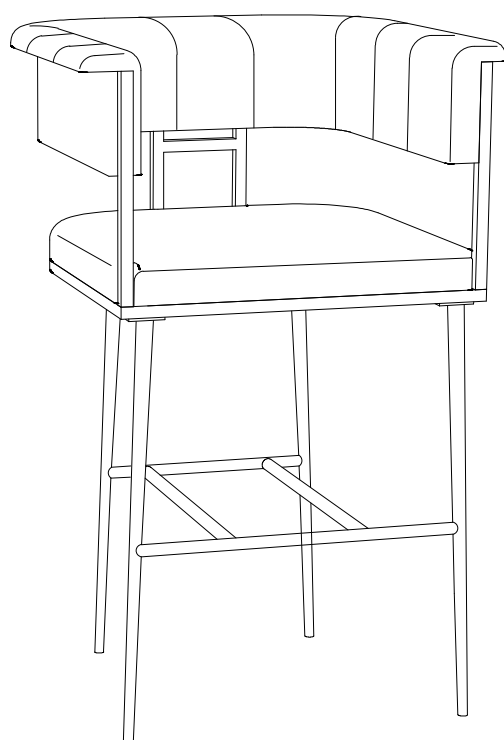



# ASTRID

---

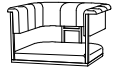

## ASSEMBLY INSTRUCTIONS







## PARTS LIST

LABEL	PICTURE	DESCRIPTION	QTY.
A		CHAIR	1
B		FRONT LEGS	1
C		BACK LEGS	1
D		STRETCHER	2

## HARDWARE

LABEL	PICTURE	DESCRIPTION	QTY.
1		M6 x 10	20
2		ALLEN KEY K4	1
3		Washers M6	16

### BEFORE BEGINNING ASSEMBLY :

-  Read instructions cover to cover
-  Have two adults on hand for assembly
-  Do NOT assemble on flooring or carpet. Assemble on a clean non-marring surface ( ex: packing foam )
-  Save all packaging until assembly is completed

## ASSEMBLY STEPS

### STEPS 1

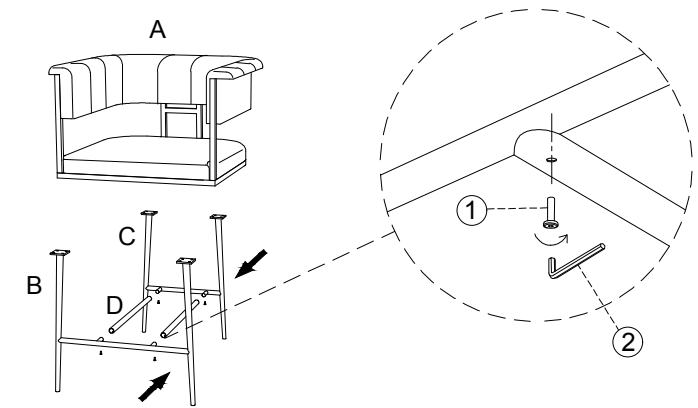

Attached the 2 stretcher to the leg rail with the M6 x 15 bolt.

### STEPS 2

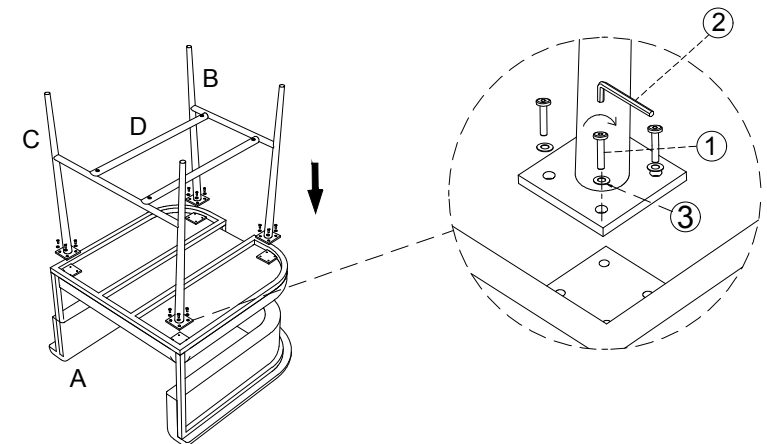

> Position the legs on the chair bottom as shown.

Keep the bolts loose during setup and tighten once all 4 legs are aligned properly.

## CARE & MAINTENANCE



Do not put hot items directly on furniture surface.



Do not clean furniture with harsh cleansers or polish.



Dust and wipe up spills using a clean, non-colored, lint-free cloth.



Stains may be removed with mild soap solution and a damp cloth.



Do not place furniture under direct sunlight.



Do not place furniture near heating or cooling vents.



Do not write on furniture without a padded barrier to protect the surface.



Do not place furniture outside, for indoor use only.

## CARE & MAINTENANCE FOR FABRIC

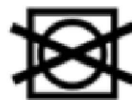
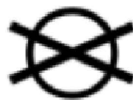

Advise dry-cleaning only.

In case of stains , use a clean towel with some warm water.

Chemicals are not advised.