



LIVING SPACES



ASSEMBLY INSTRUCTIONS

ITEM 305-P324270 Upholsterd Side Chair





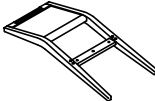
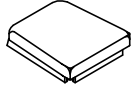

Thank you for purchasing this quality product. Be sure to check all packing material carefully for small hardware which may have come loose inside the carton during shipment. Identify and count all hardware and compare with the hardware list below.

When placing furniture on non-carpeted flooring, HMI recommends the use of floor protection such as an area rug or furniture pads. Area rugs and padding not included with purchase.

PARTS LIST

No.	Description	Sketch	Quantity
1	Chair Back		1
2	Seat Cushion		1
3	Front Leg		2

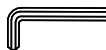
HARDWARE LIST

No.	Description	Sketch	Side	Quantity
A	Flat washer		ø5/16"×19×2mm	9
B	Lock washer		ø5/16"	9
C	Allen Bolt		ø5/16"×1-3/4"	1
D	Allen Bolt		ø5/16"×3-1/4"	4
E	Allen key		ø5/16"	1
F	Het Nut		ø5/16"	4
G	Open Wrench		ø5/16"	1

STEP 1

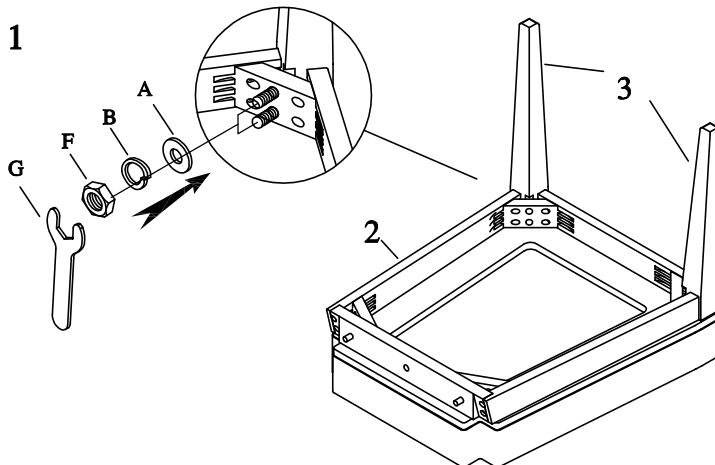

ASSEMBLY INSTRUCTIONS

**ITEM 305-P324270
Upholsterd Side Chair**

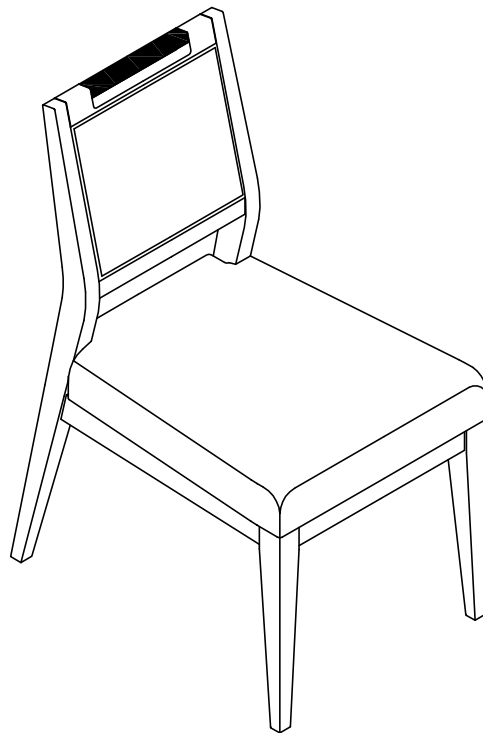
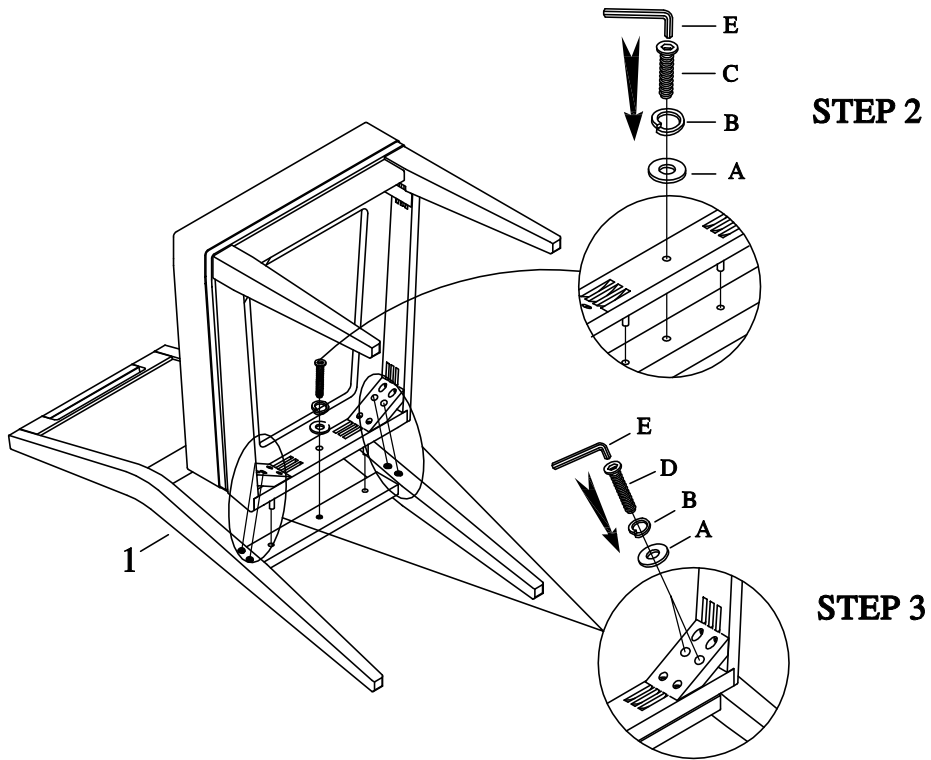

REPLACEMENT PARTS

**ITEM 305-P324270
Upholsterd Side Chair**

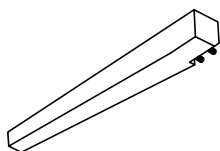

x2 RP324270-LEG - Leg

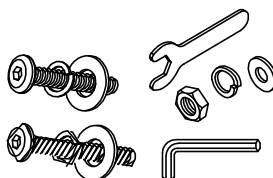

x1 RP324270-HWKIT-Hardware Kit