

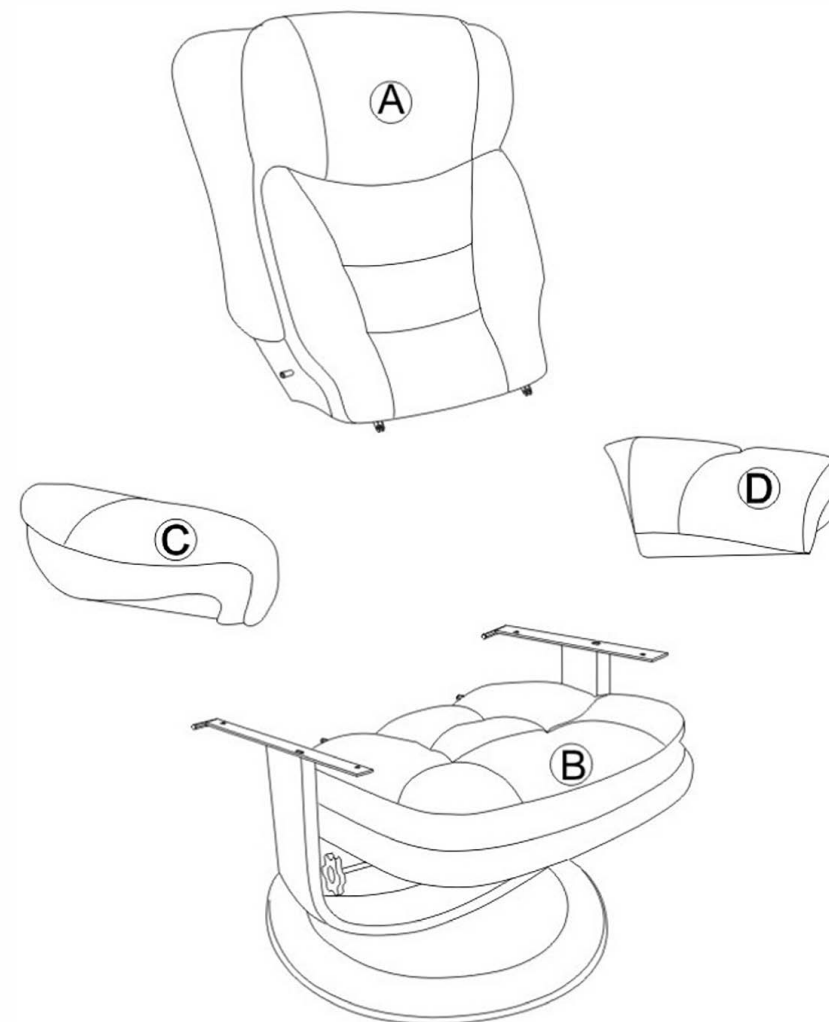





LIVING SPACES

Assembly Instructions

Components

Simple Assembly Instructions—Please keep for future reference



Chair parts List	Hardware List	
Ⓐ 1xBack Cushion		① 2×M8x55mm
Ⓑ 1xSeat Cushion		② 2×M8x30mm
Ⓒ 1xLeft Arm Cushion		③ 6×M8x20mm
Ⓓ 1xRight Arm Cushion		④ 2×M8mm
		⑤ 2×M8mm
		⑥ 1×M5

⚠ MAKE SURE ALL BOLTS, NUTS AND SCREWS ARE COMPLETELY TIGHTENED.

⚠ IF THE BOLTS, NUTS AND SCREWS ARE NOT COMPLETELY TIGHTENED THE CHAIR WILL BE LOOSE AND LEAN.

Simple Assembly Instructions—Please keep for future reference

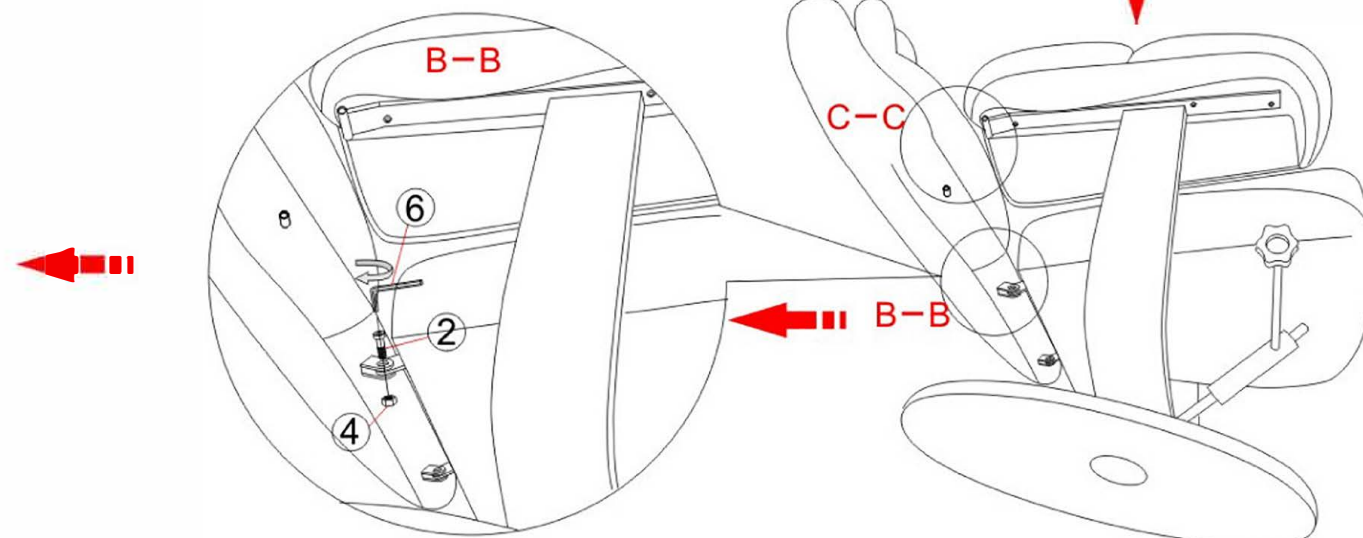
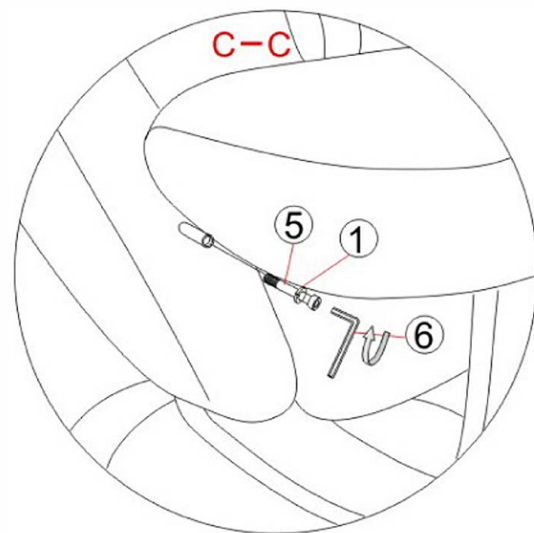
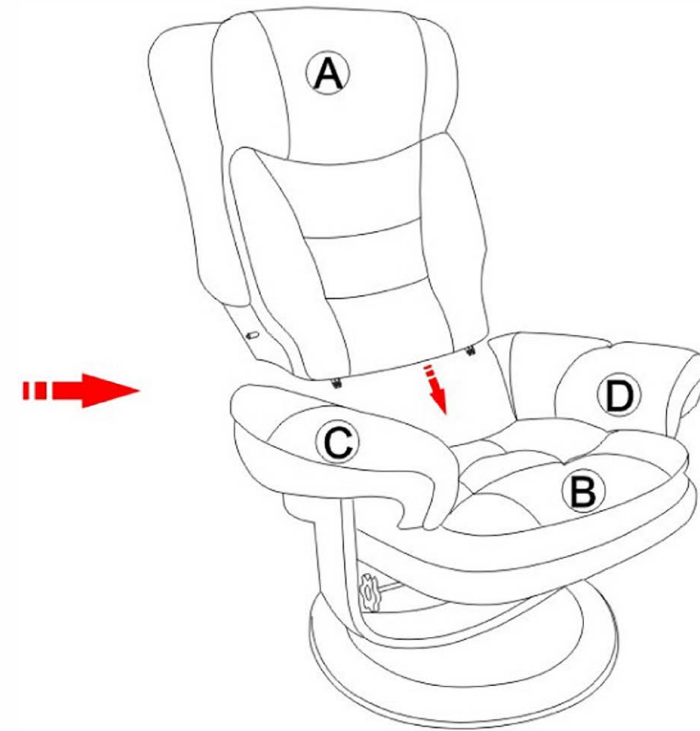
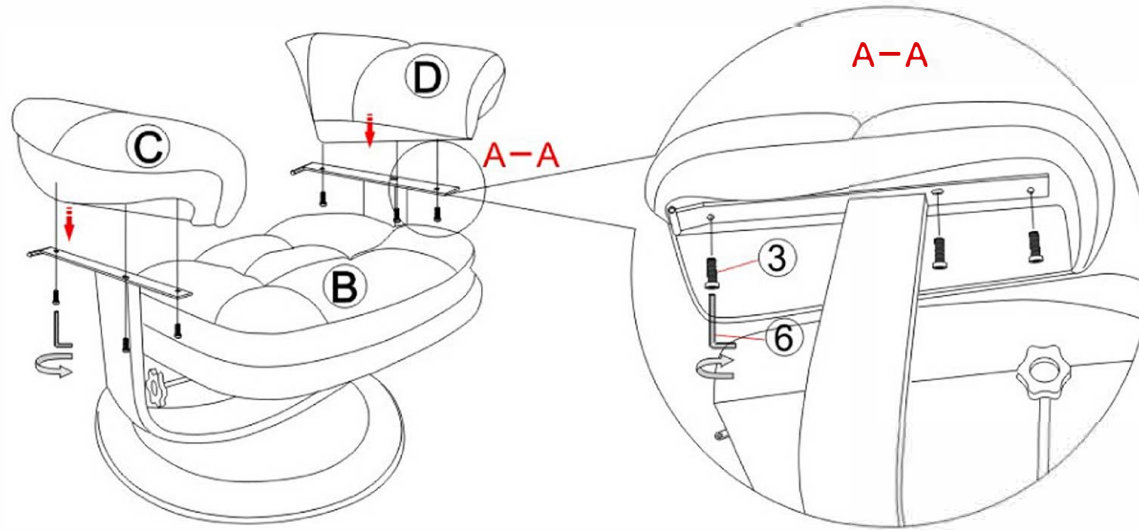

■ MAKE SURE ALL BOLTS, NUTS AND SCREWS ARE COMPLETELY TIGHTENED.

■ IF THE BOLTS, NUTS AND SCREWS ARE NOT COMPLETELY TIGHTENED, THE CHAIR WILL BE LOOSE AND LEAN.