





Thank you for purchasing this quality product. Be sure to check all packing material carefully for small parts that may have come loose inside the carton during shipment.

Key Parts			
No	Code	Qty	Description
1	1981-340KDP02S	2 Pcs	Short Legs (Back)
2	1981-340KDP02L	2 Pcs	Long Legs (Front)
3	1981-340KDP40	1 Pc	Back
4	1981-340KDP41	1 Pc	Seat

Hardware kit(1981-340KDP46)			
No	Description		Qty
A		Bolt 8x40mm	2 Pcs
B		Flat Washer	2 Pcs
C		Lock Washer	2 Pcs
D		Nut 8mm	2 Pcs
E		Key Wrench	1 Pc

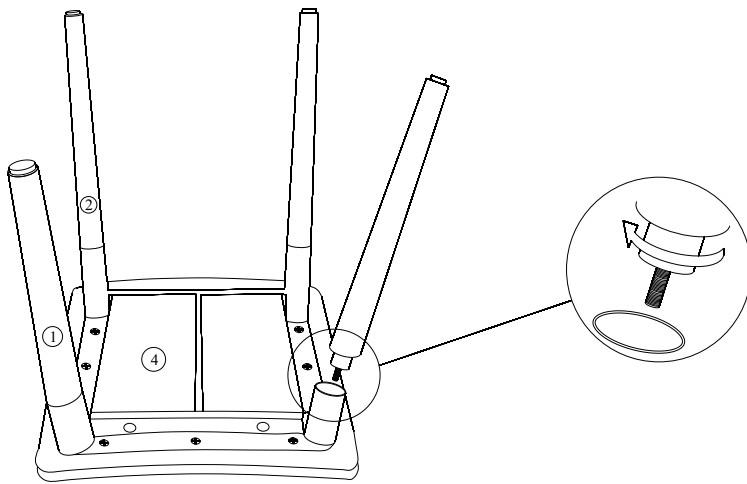

STEP 1:
Put the chair on elevated flat surface or table while fixing legs. Insert the front legs (2) and back legs (1) into the appropriate slot. Fully tighten the legs until fully secure in place.

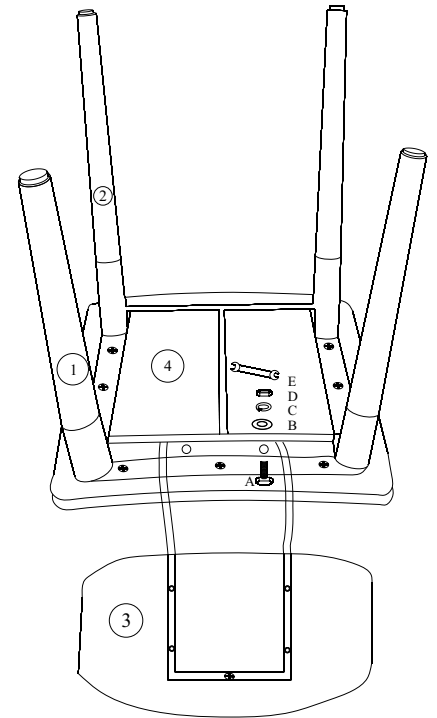
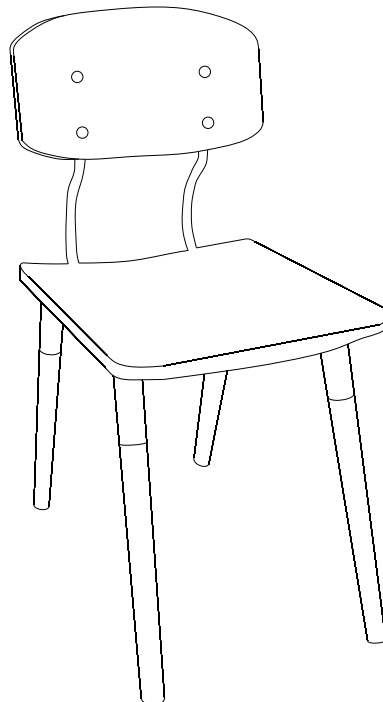

STEP 2:
Attach the back using a bolt, lock washer, flat washer & nut. Hand tighten with wrench provided.