

LIVING SPACES







OWNER'S MANUAL

SANDI DINING TABLE
LIVING SPACES SKU : 271453
VENDOR ITEM NO. : 4KBX61

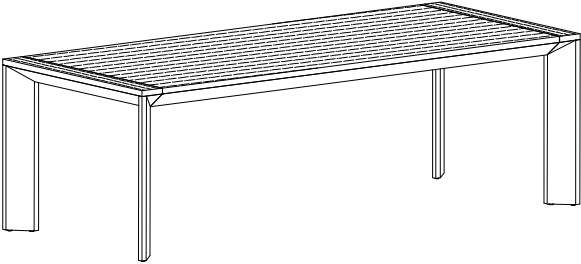

Scan QR code to view assembly video

ASSEMBLY PARTS LIST

SKU #	IMAGE	DESCRIPTION	QUANTITY	FULLY ASSEMBLED
271453-1		TABLE TOP	1	
271453-2		LEG	2	
HARDWARE KIT PACKED IN BOX SKU : 4KZZ61HW				
SKU #	IMAGE	DESCRIPTION	QUANTITY	
4KZZ61HW-1		ALLEN BOLT (5/16" x 40mm)	12	
4KZZ61HW-2		LOCK WASHER (M8)	12	
4KZZ61HW-3		FLAT WASHER (M8)	12	
4KZZ61HW-4		ALLEN KEY	1	

PRE-ASSEMBLED PARTS LIST

SKU #	IMAGE	DESCRIPTION	SKU #	IMAGE	DESCRIPTION
4KZZ61FC		FOOT CAP			

LIVING SPACES

OWNER'S MANUAL

SANDI DINING TABLE
LIVING SPACES SKU : 271453
VENDOR ITEM NO. : 4KBX61



Scan QR code to view assembly video

ASSEMBLY INSTRUCTIONS



1

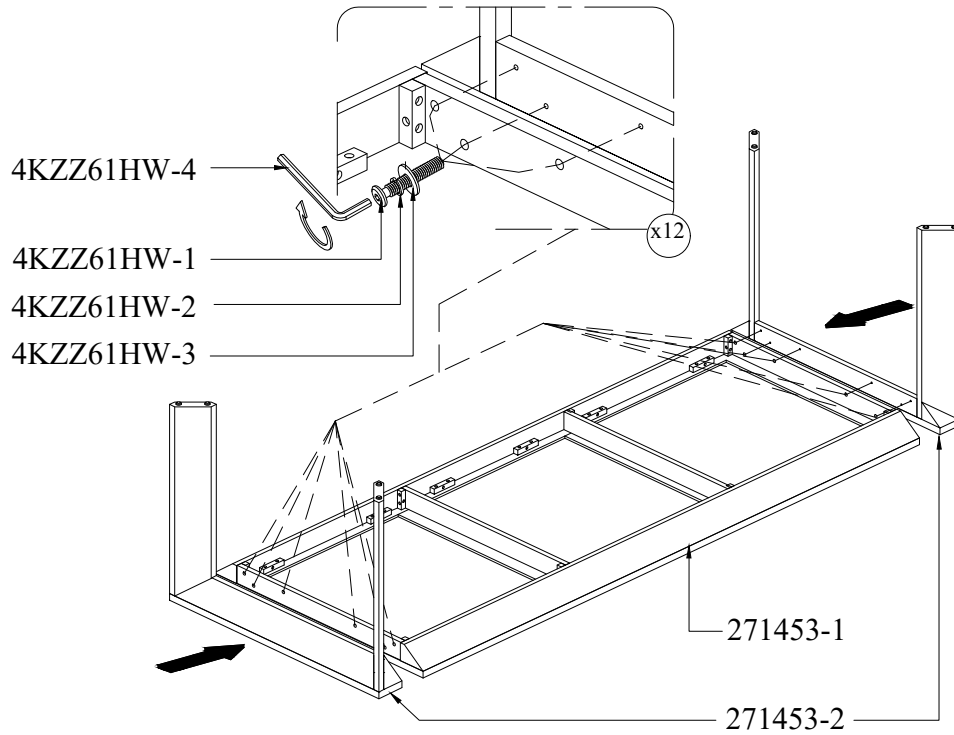

2

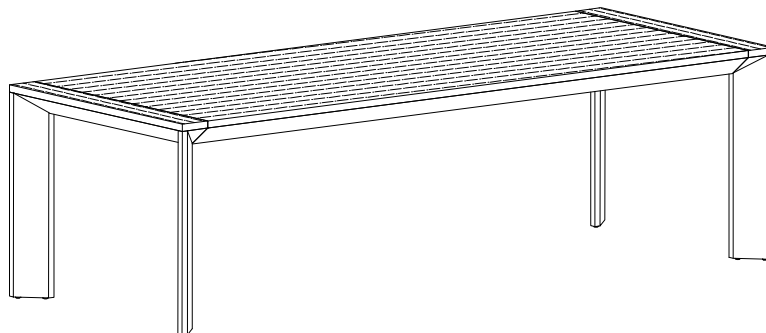

ASSEMBLY COMPLETE

LIVING SPACES

OWNER'S MANUAL

SANDI DINING TABLE
LIVING SPACES SKU : 271453
VENDOR ITEM NO. : 4KBX61



Scan QR code to view assembly video



WARNING:

- Maximum distributed load capacity: 430 lbs.
- Sitting, standing or jumping on this product may result in damage or injury.

ROUTINE MAINTENANCE:

Periodically check all fittings and tighten if necessary, as they can loosen over time.

CARE AND CLEANING:

SOLID WOOD FURNITURE

Congratulations on purchasing this handcrafted solid wood furniture product. Please keep in mind that wood is sensitive to changes in humidity. As the weather changes so does the relative humidity in your home and the moisture content of your solid wood furniture. We have taken every precaution to stabilize the lumber used to build this product. Still, you may observe plank movement or small cracks as the seasons change, particularly during the first 6-12 months of ownership. This is normal for solid wood furniture and will not affect the performance or longevity of this product.

Dust frequently with a clean, damp, lint-free cloth. Frequent dusting will remove abrasive build-up which can damage a finish over time. Avoid using oily polishes or waxes. Avoid exposing your furniture to strong sunlight. Prolonged exposure to direct sunlight can fade the finish of your furniture. Do not expose your furniture to any liquids. Never allow water to sit on your furniture. Do not place hot items on top of surface, always use a mat or other protector. Alcohol, nail polish and perfume are also dangerous, as they can dissolve the furniture finish on contact and may require professional repairs.