

















NATE + JEREMIAH

FOR LIVING SPACES

A	PB5308-50HD2-A	 x8 Ø5/16"x4-1/2"L
B	PB5308-50HD2-B	 x8 Ø5/16"x34x16x3mm
C	PB5308-50HD2-C	 x8 Ø5/16"x17mm
D	PB5308-50HD2-D	 x1 Wrench 12mm
E	PB5308-50HD1-E	 x14 Ø5/16"x19x2mm
F	PB5308-50HD1-F	 x14 Ø5/16"x12x2mm
G	PB5308-50HD1-G	 x14 Ø5/16"x1-3/4"L
H	PB5308-50HD3-H	 x8 #4x25mm
1	PB5308-50HB	 x1
2L	PB5308-50HLL	 x1
2R	PB5308-50HRL	 x1
3	PB5308-50MP	 x2
4	PB5308-50SR	 x1
5	PB5308-50FB	 x1
6	PB5308-50R	 x2
7	P99-00QSL	 x4 1545x76x18mm
8	PB5308-50SS	 x4 203x34x34mm

TOOLS REQUIRED (NOT PROVIDED):

PHILLIPS SCREW DRIVER 

BRIGHTON

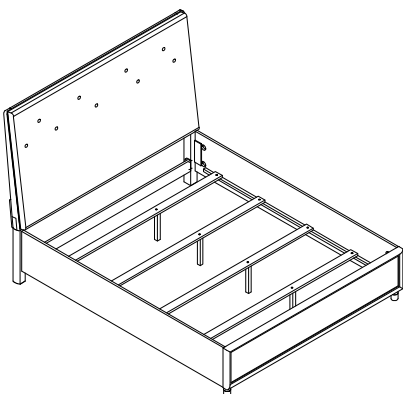

269634/B5308-50H Queen Island Bed Uph HB
269633/B5308-50F Queen Island Bed Uph FB
269635/B5308-50R Queen Island Bed Uph Rails

