

CAPRI OUTDOOR ROUND BARSTOOL

20BC083A-W

Assembly Instruction

Parts List:









REF	PART NAME	PART IMAGE	QTY	REF	PART NAME	PART IMAGE	QTY
A	SEAT		1	E	BOLT (M6*15L)		4
B	LEG		1	F	BOLT (M6*30L)		4
C	CONNECTING RING		1	G	PE CAP		12
D	WASHER		8	H	ALLEN WRENCH		1

Diagram:



Assembly Steps:

Step 1: Remove protective wrapping and lay all parts on floor. Identify all parts packed in Carton against attached parts list to make sure all parts are presented.

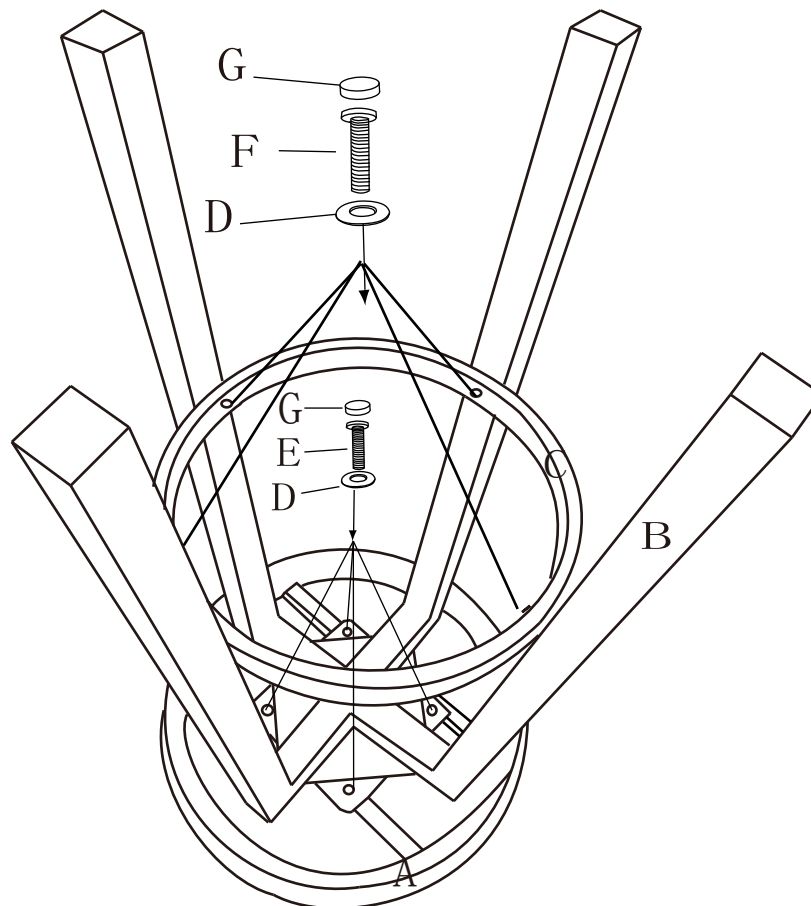
Step 2: After putting the leg (B) upside down, take out the link ring (C) and align it with the hole, as shown in the picture, use the gasket (D) screw (F) PE cap (G).

Step 3: Take the seat (A) upside down and take out the assembled legs (B) to align with the hole, as shown in the figure, use the gasket (D) screw (E) PE cap (G).

NOTE: IT IS USER'S RESPONSIBILITY TO MAKE SURE ALL PARTS ARE ASSEMBLED AND TIGHTENED PROPERLY AND SECURELY.