

ASSEMBLY INSTRUCTIONS

**CROWNMARK B4630/B4620-2
NIGHT STAND**

STEP 1 : Pull the drawer and take out the Bunfoot carton (B). Attach the Bunfoot (B) at the bottom Night Stand (A) used JCBC (1) with Spring Washer (2) Flat Washer (3) and tighten with Allen Wrench (4).

(BOX 1)



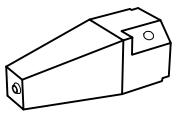

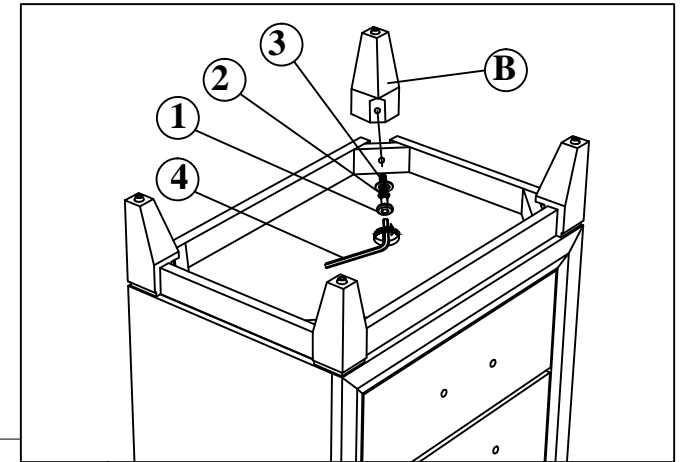
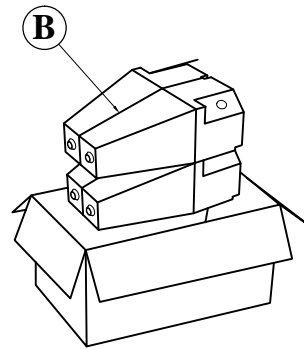
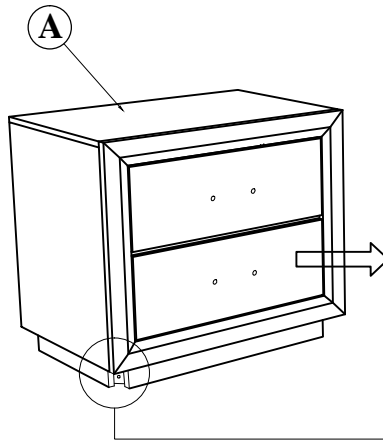
BOX OF NIGHT STAND

NO	ITEM	QTY
A	NIGHT STAND 	1 pc
B	BUN FOOT 	4 pcs



(BOX 1)

HARDWARE LIST

NO	ITEM	QTY
1	JCBC M6 x 50mm 	4 PCS
2	Spring Washer 1/4" Rbw 	4 PCS
3	Flat Washer 1/4"ID x 19mmOD Blk 	4 PCS
4	ALLEN KEY m4x65mm Blk 	1 pc

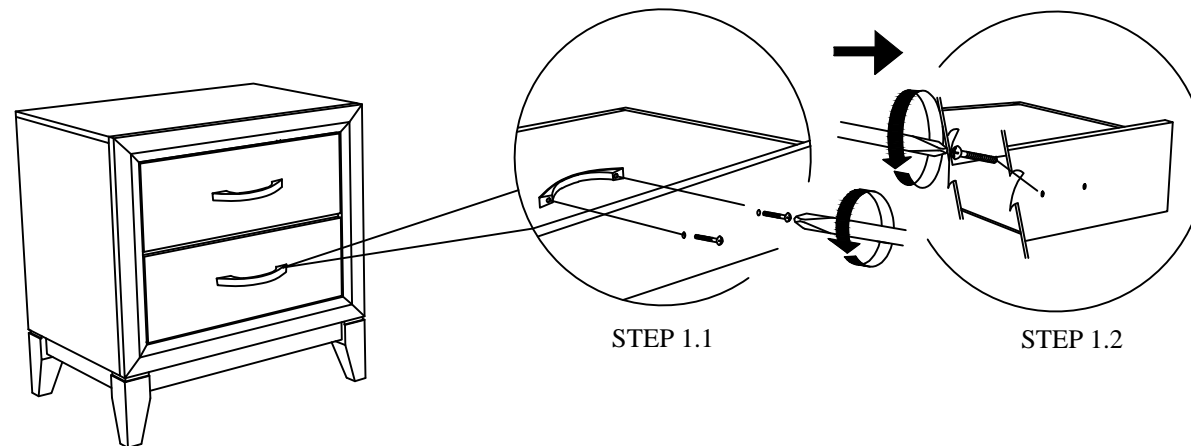

COMPLETED ASSEMBLY

NOTE : MUST TIGHTEN SCREWS **PERIODICALLY** WITH USE SCREW WILL BECOME LOOSE CHECK TIGHTNESS OF ALL SCREW EVERY 6-8 WEEKS.