



LIVING SPACES

1

A	14S05082-A		X5
B	14S05082-B		X1
C	14S05082-C		X20
D	14S05082-D		X2
E	14S05082-E		X2
F	14S05082-F		X2

14S05082 SKU#267811



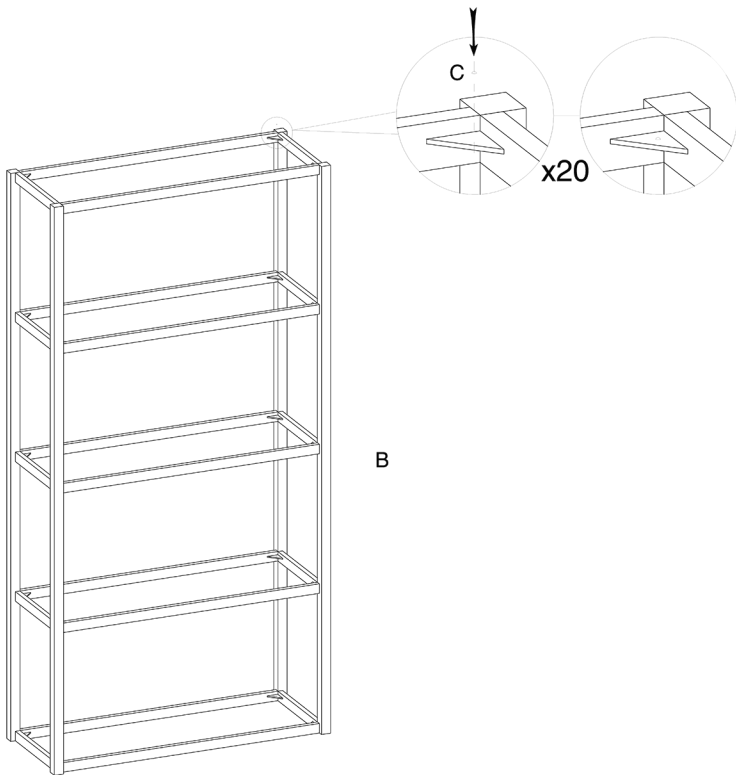
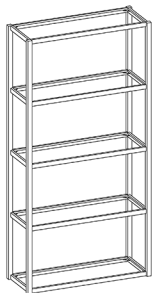



LUCITE + BRASS TALL BOOKCASE





LIVING SPACES

2

A	14S05082-A		X5
B	14S05082-B		X1
C	14S05082-C		X20
D	14S05082-D		X2
E	14S05082-E		X2
F	14S05082-F		X2

14S05082 SKU#267811

LUCITE + BRASS
TALL BOOKCASE

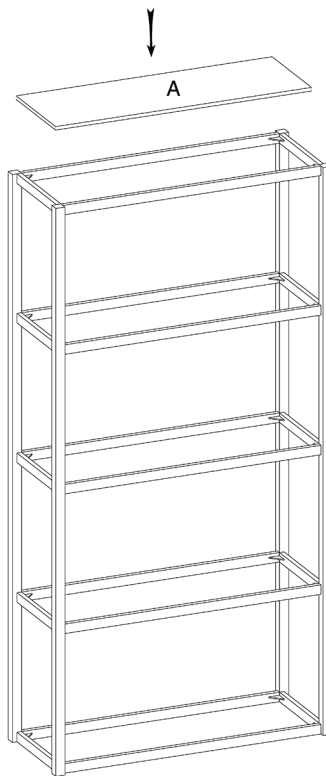
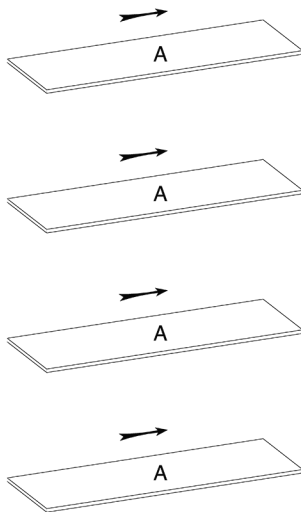
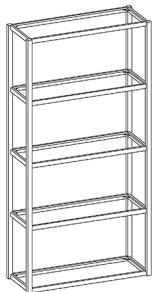









LIVING SPACES

3

ANTI TIPPING ASSEMBLY INSTRUMENT

A	14S05082-A		X5
B	14S05082-B		X1
C	14S05082-C		X20
D	14S05082-D		X2
E	14S05082-E		X2
F	14S05082-F		X2

14S05082 SKU#267811

LUCITE + BRASS
TALL BOOKCASE

