

ASSEMBLY INSTRUCTIONS

Description: Glenwood Swivel Counter Stool



Important safety instructions:

- Please carefully read all instructions before assembling.
- For your safety and ease, assembly by two or more adults is recommended.
- Keep instructions for future use.





Pre-assembly:

- Do not discard any contents until after assembly is complete to avoid accidentally discarding small parts or hardware.
- Remove all parts and hardware from box along with any plastic protective packaging.

Parts List

Item	Description	QTY
P1	Chair Top 	1
P2	Chair Base 	1



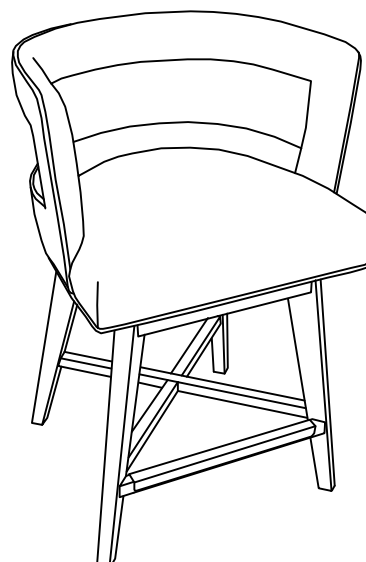

Hardware List

Item	Description	QTY
H1	Bolts Ø1/4"*1"L 	8
H2	Lock Washers 1/4" 	8
H3	Flat Washers 1/4" 	8
H4	Allen Wrench 1/4" 	1
H5	Swivel 180° 	1



Assembly Procedures:

Step 1. Assemble the stool on a flat, soft surface such as a carpet or cloth to prevent scratching the finish. Loosely attach the swivel (H5) to the top of chair base as shown below image 1.

- (H1)x4 Bolts Ø1/4"*1"L 
- (H2)x4 Lock Washers 1/4" 
- (H3)x4 Flat Washers 1/4" 
- (H4)x1 Allen Wrench 1/4" 

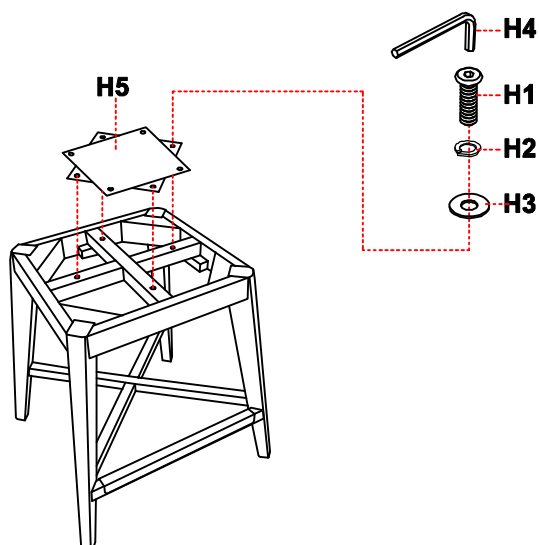





Image 1

Step 2.

1) Loosely attach the assembled chair base to the bottom of chair top (P1) to the seat bottom as shown below image 2.

2) Make sure the stool is level and securely tighten all bolts with Allen wrench (H4), see image 2.

- (H1)x4 Bolts $\varnothing 1/4" \times 1" L$ 
- (H2)x4 Lock Washers 1/4" 
- (H3)x4 Flat Washers 1/4" 
- (H4)x1 Allen Wrench 1/4" 

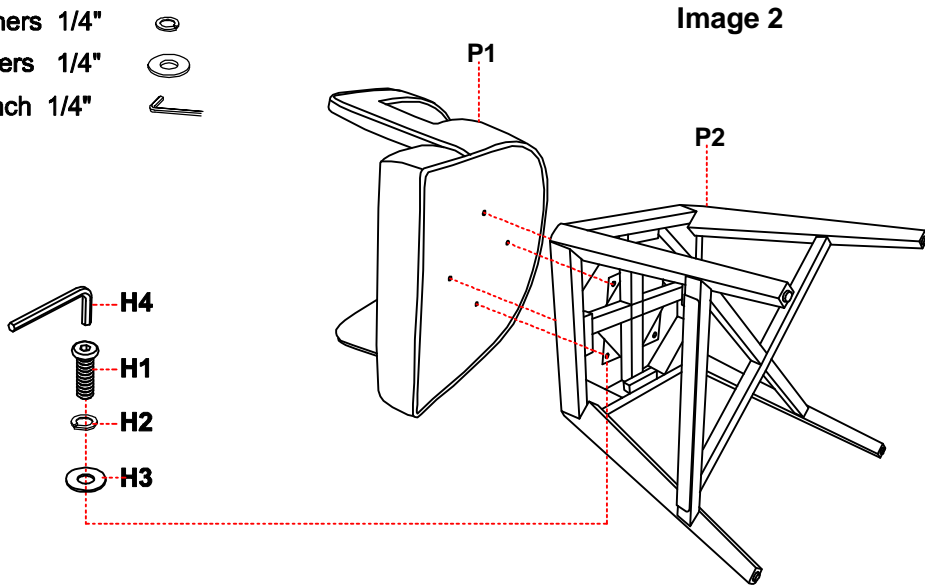

Step 3.

Turn the assembled stool to an upright position, assembly is complete. **Failure to follow these instructions may cause the bolts to misalign during assembly.**

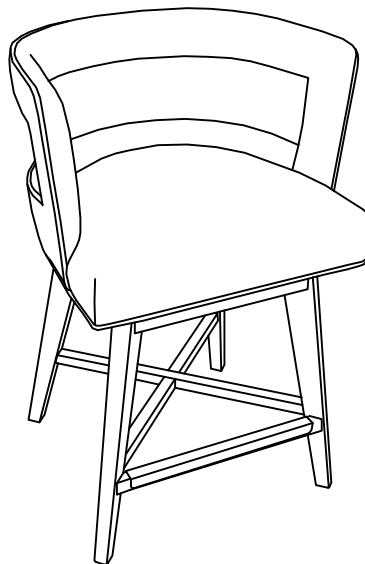

ADDITIONAL NOTE ABOUT SAFETY: BOLTS MAY LOOSEN DURING NORMAL EVERYDAY USE. THEY SHOULD BE PERIODICALLY INSPECTED AND RE-TIGHTENED TO PREVENT DAMAGE OR INJURY. ALWAYS CHECK TO BE SURE THAT ALL HARDWARE IS KEPT TIGHTENED.

Thank you for your purchase