

ASSEMBLY INSTRUCTIONS

Description: Counter Stool





Important safety instructions:

- Please carefully read all instructions before assembling the stool.
- For your safety and ease, assembly by two or more adults is recommended.
- Keep instructions for future use.

Pre-assembly:





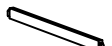
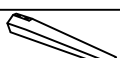

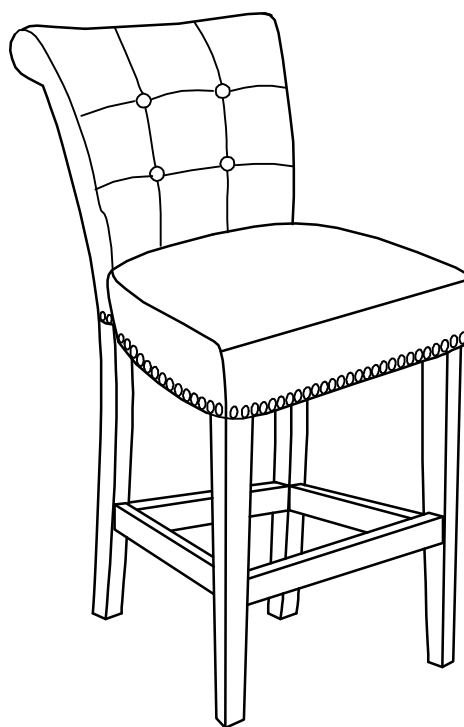
- Do not discard any contents until after assembly is complete to avoid accidentally discarding small parts or hardware.
- Remove all parts and hardware from box along with any plastic protective packaging.

Parts List

Item	Description		QTY
A	Counter Stool Back		1
B	Seat Cushion		1
C	Left Stretcher		1
D	Right Stretcher		1
E	Front Stretcher		1
F	Front Legs		2



Hardware List

Item	Description		QTY
a	Long Bolts Ø5/16**3"		6
b	Short Bolts Ø5/16**2-1/2"		4
c	Lock Washers 5/16"		10
d	Flat Washers 5/16"		10
e	Allen Wrench 5/16"		1
f	Screw #8*1-3/4"		6
g	Dowel		1

Assembly Procedures:

Step 1. Assemble the counter stool on a flat, soft surface such as a carpet or cloth to prevent scratching the finish. Insert the dowel (g) into the stool back, then attach the seat cushion (B) to counter stool back (A) using bolts (a), lock washers (c) and flat washers (d). Loosely tighten the bolts with Allen wrench (e).

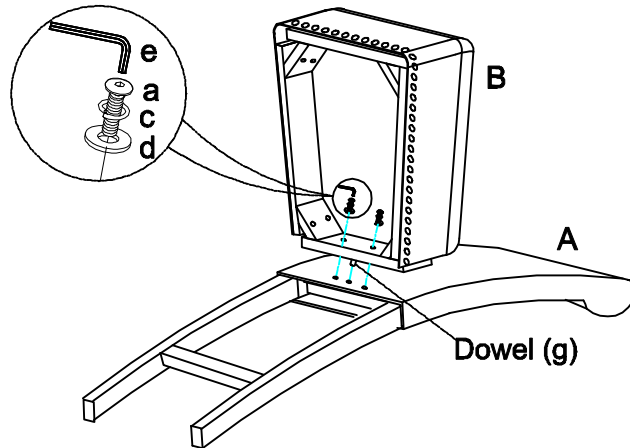

Step 2. Attach the seat cushion (B) to the leg of counter stool back (A) using bolts (a), lock washers (c) and flat washers (d). Loosely tighten the bolts with Allen wrench (e).

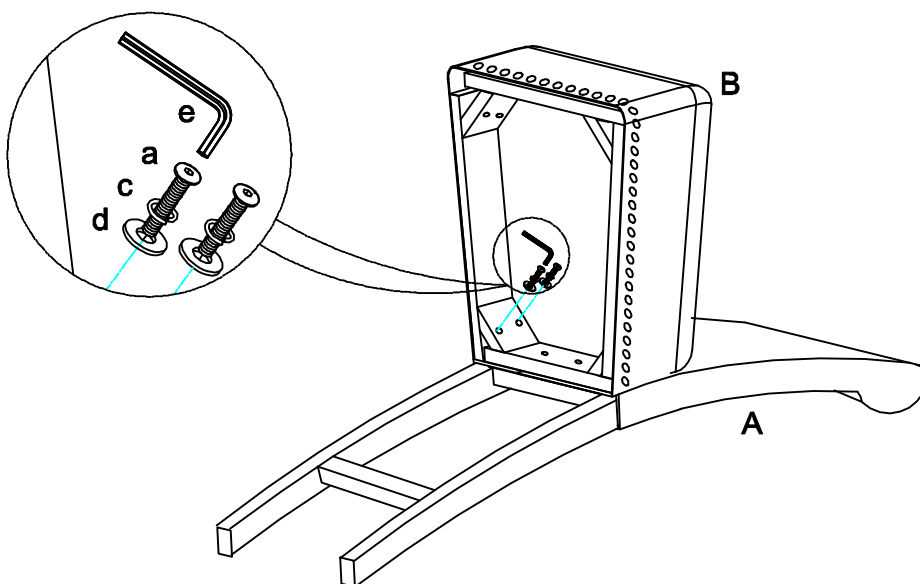

Step 3. Insert the right stretcher (D) to the leg of chair back (A) according to the label "R" at the hole in the leg of counter stool back and the front end of right stretcher (D). Loosely attach the front leg (F) to the bottom of seat cushion (B) and the stretcher (D) using bolt (b), lock washer (c), flat washer (d) and Allen wrench (e). Do not tighten the screws at this time.

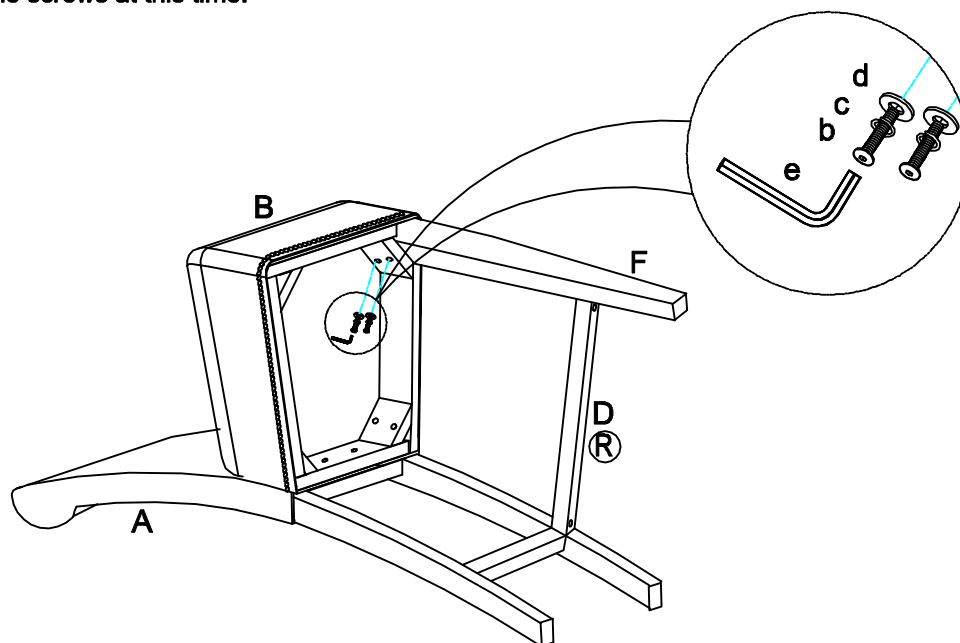

Step 4.

- 1) Insert the left stretcher (C) to the leg of counter stool back (A) according to the label "L" at the holes in the legs of counter stool back and the front end of left stretcher (C). Loosely attach the front leg (F) to the seat cushion (B) using bolt (b), lock washer (c), flat washer (d) and Allen wrench (e). Do not tighten the screws at this time.
- 2) Insert the front stretcher (E) between the front legs.
- 3) Securely tighten all bolts, but do not over tighten the bolts.
- 4) Tighten all screws (f) through the stretchers (C, D, E) to the front legs and counter stool back legs with screw driver(not provided).
- 5) Assembly is complete.

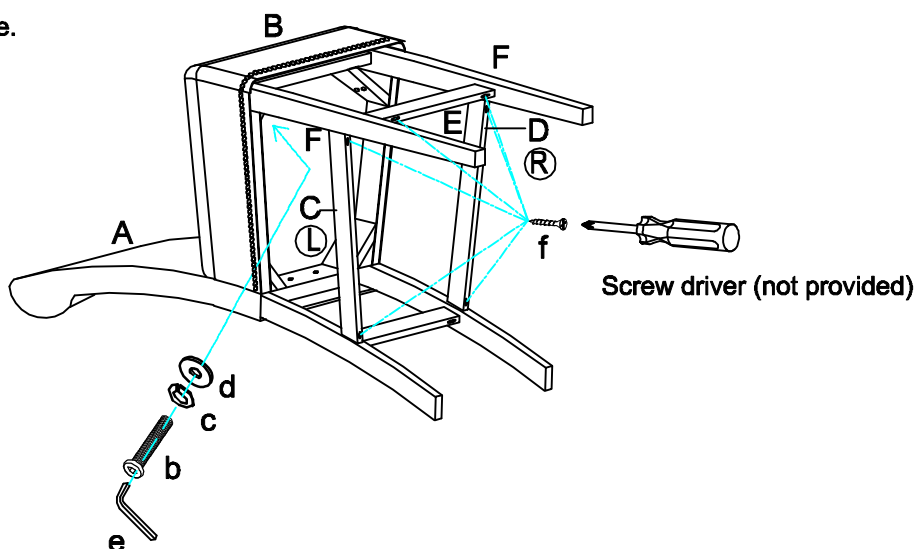

ADDITIONAL NOTE ABOUT SAFETY: BOLTS MAY LOOSEN DURING NORMAL EVERYDAY USE. THEY SHOULD BE PERIODICALLY INSPECTED AND RE-TIGHTENED TO PREVENT DAMAGE OR INJURY. ALWAYS CHECK TO BE SURE THAT ALL HARDWARE IS KEPT TIGHTENED.

Thank you for your purchase