

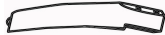





MADISON PARK

Assembly Instruction--Dining Chair

PARTS #	PARTS NAME	DRAWING	QTY
P1	FRONT LEGS		2
P2	BACK RIGHT LEG		1
P3	BACK LEFT LEG		1
P4	Chair		1

Hardware#	PARTS NAME	DRAWING	QTY
H1	Bolts $\phi 5/16 \times 2-3/8$ "		8
H2	Lock Washers $\phi 5/16$ "		8
H3	Flat Washers $\phi 5/16$ "		8
H4	Allen Wrench $\phi 5/16$ "		1

1. Turn the chair upside down and lay on protective carpet, take out the legs and hardware from the bottom.

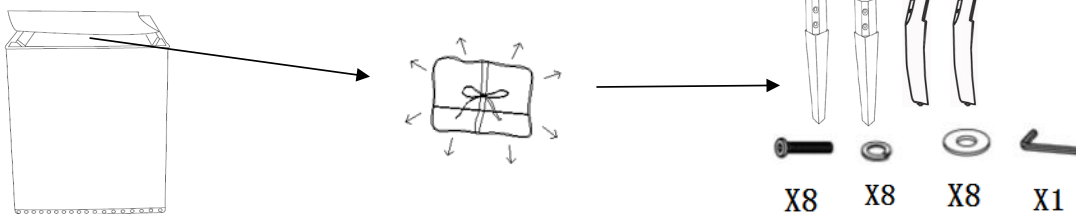

2. Using bolts (H1), lock washers (H2), flat washers (H3), connect legs (P1, P2, P3) to chair (P4). Tighten bolts (H1) with Allen Wrench (H4).

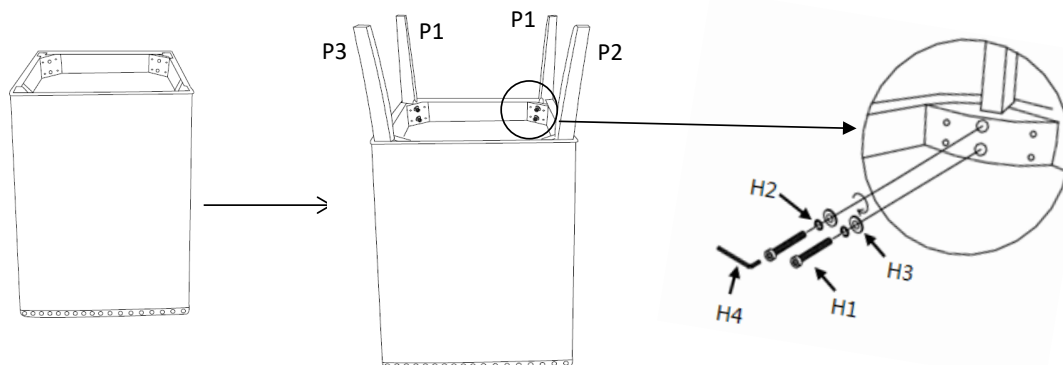

3. Place chair upright on a level surface. Assembly is complete.

