







ASSEMBLY INSTRUCTIONS

ITEM NO : 51681

Parts required

1		Bolt	Φ12*25MML	2 pcs
2		Nut	Φ12MM	8 pcs
3		Wrench		1 pc
4		Bolt	Φ12*60MML	8 pcs

A		wooden seat	1 pc
B		metal legs	2 pcs
C		metal bar	1 pc

1.

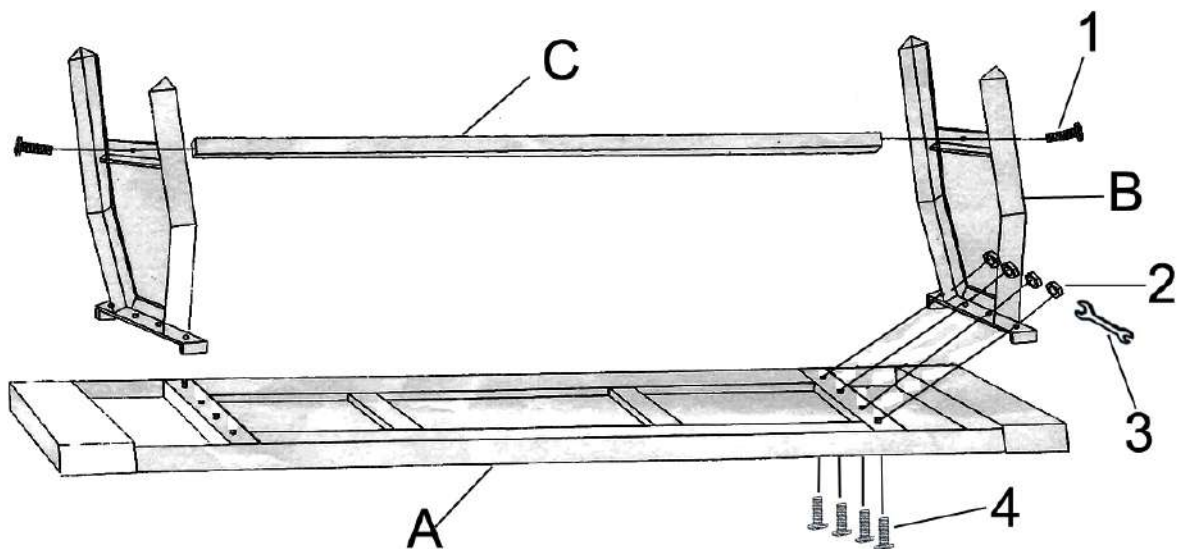

2.

