

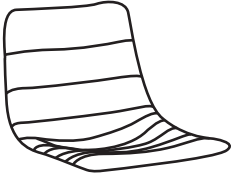

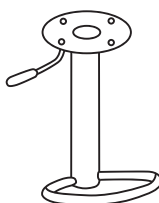

**ITEM NAME / NOM D'ITEM: PRIMA BAR CHAIR**

**ITEM #/NO. ITEM: 101453/101454/101455/101456/101812/101813**

**PART LIST / LISTE DES PIÈCES**

(1)	(2)	(3)	(4)	(5)
				<p>A.  M6x18mm x4</p> <p>B.  M6x18mm x4</p> <p>C.  6mm x1</p>
x1	x1	x1	x1	

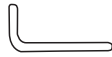
**ASSEMBLY INSTRUCTIONS / INSTRUCTIONS D'ASSEMBLAGE**

I.

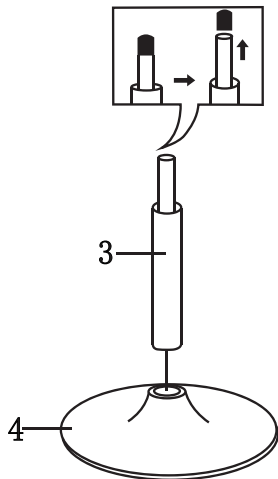

II.

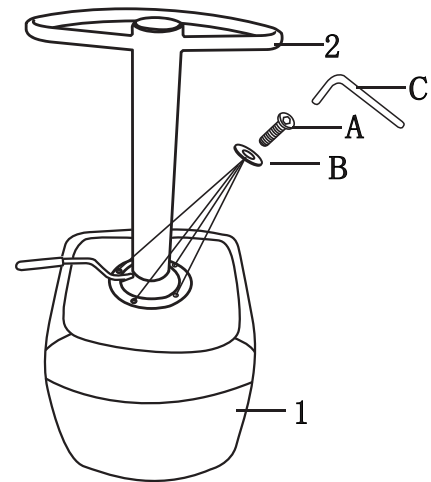

III.

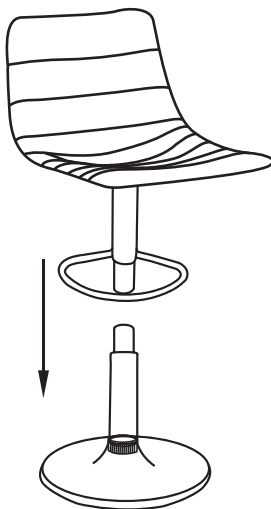

IV.

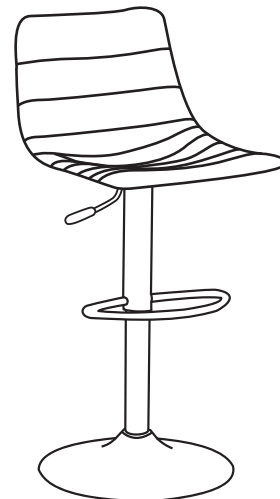

For missing parts or damaged parts, please call

USA : 1-866-798-6663

Canada : 514-382-6661

AI-1-191202