

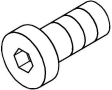

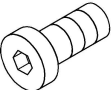

Baxton Assembly Instructions

Hardware packed behind the headboard.

A1	C	E	F	I	Y	Z
						
Φ8*40MM	Φ8*45MM	Φ8 MM	H=99 CM	Φ8 MM		
4PCS	6PCS	14PCS	2PCS	1PC	1PC	4PCS

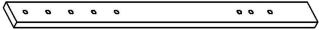
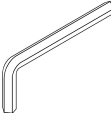

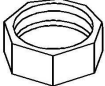
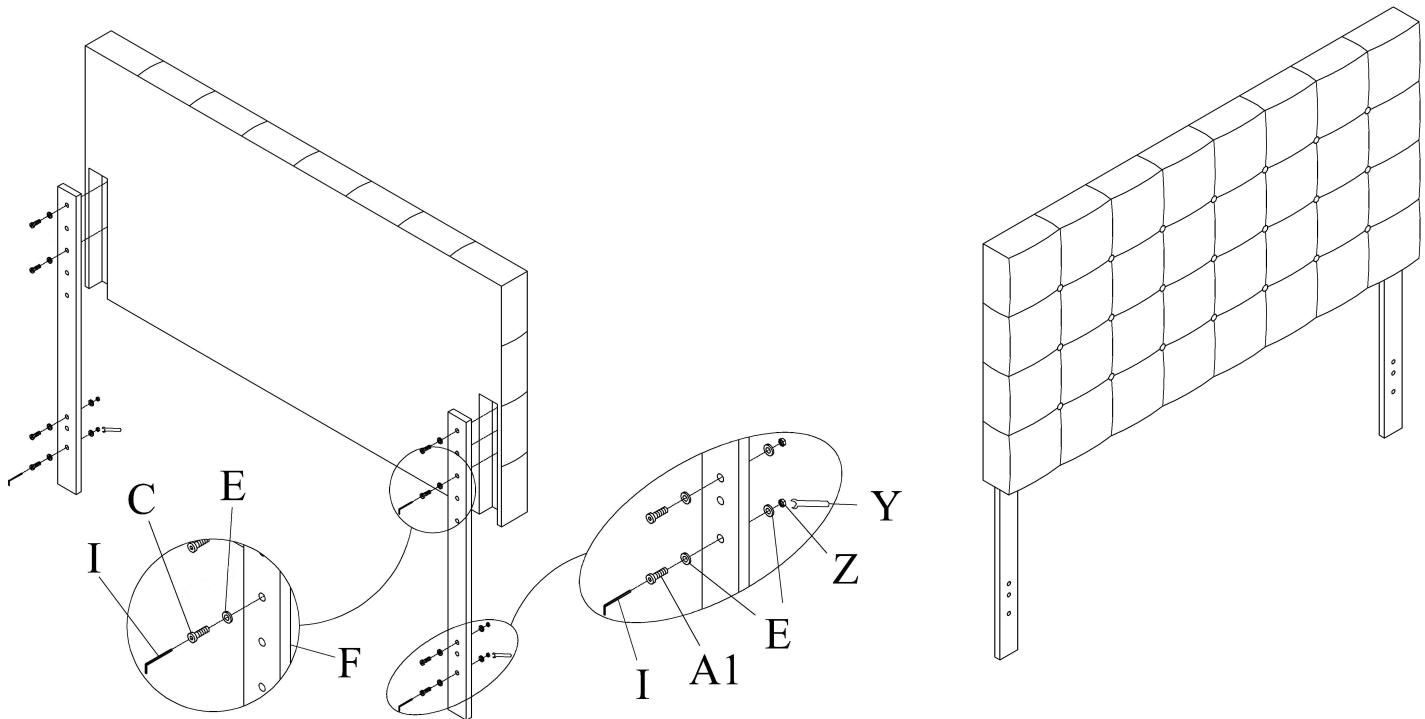
Step#1

Retrieve headboard legs and hardware from behind the headboard.

Step#2

Attach headboard legs (F) to the headboard using Wrench (I), Bolt (C) and Washer (E).

CONGRATULATIONS ON YOUR NEW BED PURCHASE

~Warning: do not move bed after final assembly as it may result in damages to floor and/or bed.~

Remark:

The installation height of the headboard legs can be adjusted as required.

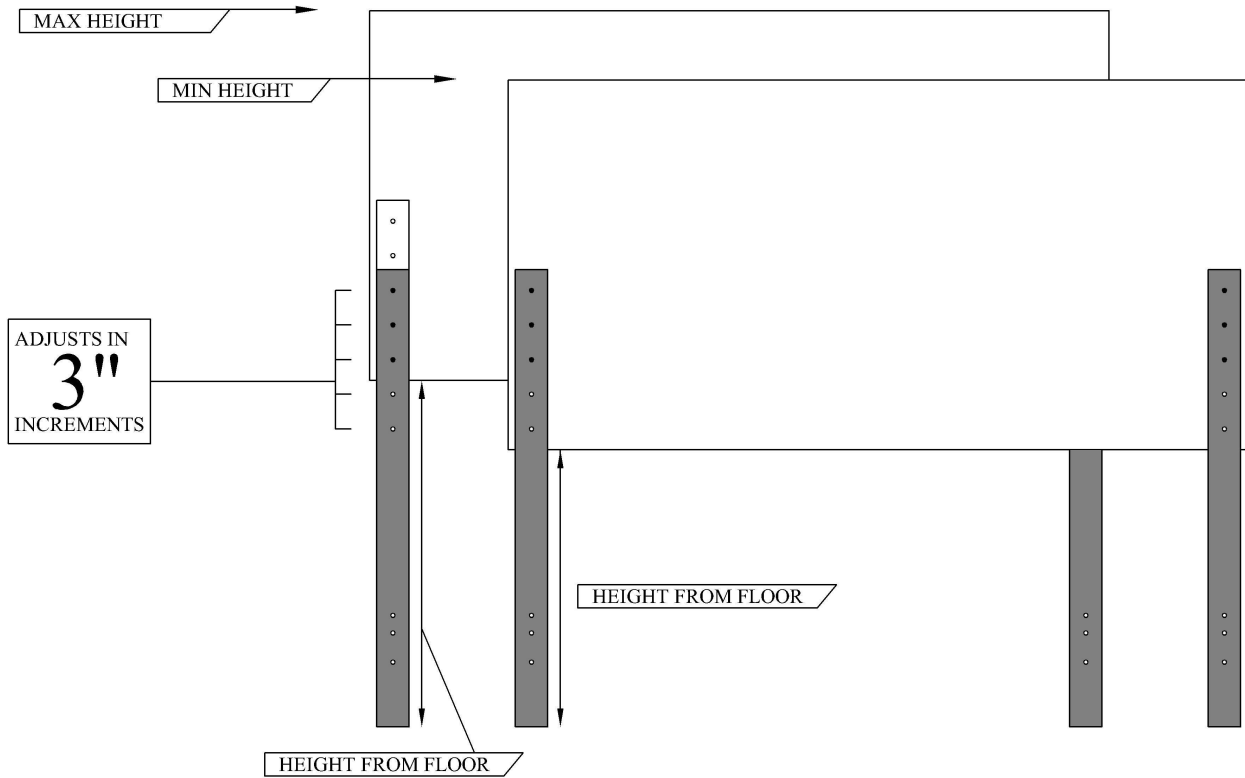

CONGRATULATIONS ON YOUR NEW BED PURCHASE

~Warning: do not move bed after final assembly as it may result in damages to floor and/or bed.~