



LIVING SPACES



PANAMA OUTDOOR DINING BENCH

19BH030A-W

253557

Assembly Instruction

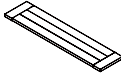
Parts List:

REF	DESCRIPTION	IMAGE	QTY
A	TABLE TOP		1
B	TABLE LEG		2

Hardware List:



REF	DESCRIPTION	IMAGE	QTY
022	BOLT (M6*35L)		8
004	WASHER (M6,ID Ø6.5,OD Ø12)		8
001	ALLEN WRENCH (M6)		1

Diagram:

Step 1



Step 2

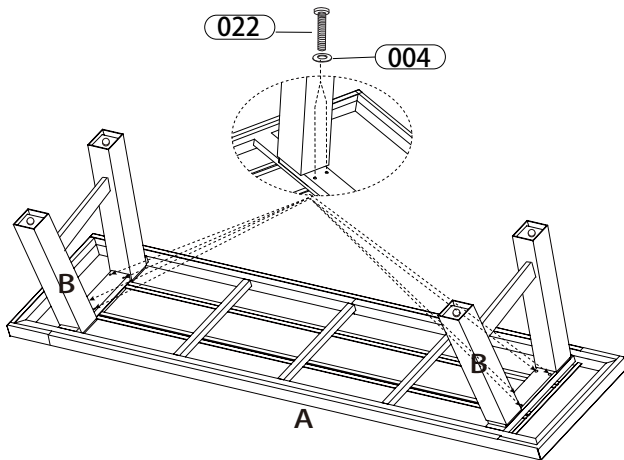
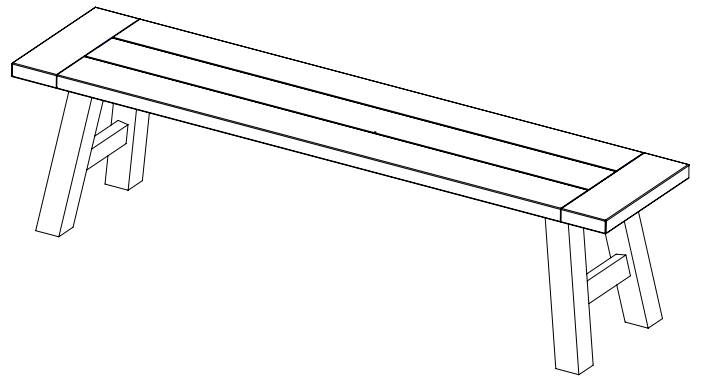

Assembly Steps:

Tip- Remove protective wrapping and lay all parts on floor. Identify all parts packed in Carton against attached parts list to make sure all parts are presented.

Step 1: Install (B) on (A) as shown in diagram, using bolt (022) and washer (004).

Step 2: After all bolts are aligned properly before tightening. With a second person's Assistance carefully turn the table over onto its legs. Make sure legs rest on a flat surface.

NOTE: IT IS USER'S RESPONSIBILITY TO MAKE SURE ALL PARTS ARE ASSEMBLED AND TIGHTENED PROPERLY AND SECURELY.